

# StrainMaster

Digital Image Correlation Systems  
for Full Field  
Shape, Displacement and Strain



**LAVISION**

FOCUS ON IMAGING



## Optical Technology for Full Field Strain Measurement

LaVision **StrainMaster** products are versatile optical measurement systems for surface displacement, strain, and shape analysis based on **digital image correlation** (DIC). Application areas include, but are not limited to, classical material testing (tension, compression, fatigue), dynamic material response (impact / blast loading, cyclic testing), complex deformation states (shrinkage, multi-axial loading), thermomechanical testing, and **fluid-structure interaction** (FSI). Providing there is optical access, **StrainMaster** systems offer a contactless, non-intrusive and robust method to measure full-field surface deformation.



## System Features

- ▶ complete camera integration including high-speed devices
- ▶ Device Control Unit (DCU) 11 for synchronization of devices with integrated A/D converter
- ▶ complete control, analysis, and data management within one software package
- ▶ total control over data post-processing – your raw data is always available
- ▶ compact and robust mechanics
- ▶ live gauge extensometer mode with optional scaled analogue output for strain control
- ▶ comprehensive 3D display of data
- ▶ virtual gauge and extensometer plot
- ▶ dedicated Add-on for MATLAB®, and export formats including ABAQUS® INP
- ▶ lifetime email and phone support and incremental software upgrades included



The **StrainMaster** system follows a modular concept that allows you to retrofit individual hardware and software components according to your requirements at any time. In combination with a Device Control Unit and one or more cameras, you have complete control over the acquisition and recording parameters. The standard software package is available as a powerful standalone product capable of importing and processing images from external sources such as scanning electron microscopes. Software licenses are available as single- or multi-user version and additional modules or network seats can be added at any time. The one one-time fee for each license covers incremental downloadable updates together with phone and email support for the lifetime of the software. No monthly or annual maintenance fees are charged. LaVision can also offer special network licenses for teaching and training purposes.

The **StrainMaster** systems can be split into 3 basic categories (in addition to the **digital volume correlation** software) which accommodate the needs of all scenarios and applications.

**StrainMaster Compact** represents the ultimate solution in terms of simplicity and size. This pre-calibrated system contains two cameras and light source, and is an ideal low-cost system for repeat testing applications, teaching, and difficult to access measurement areas, amongst many others. A typical system consists of:

- ▶ **StrainMaster Compact** measuring head
- ▶ **DaVis** DIC 3D software
- ▶ DCU 11 controller including A/D converter
- ▶ tripod based mount



Four different variants are available covering different measurement areas.



**StrainMaster Portable** is a flexible platform suitable for many different applications requiring 2D or 3D DIC capability and typically consist of

- ▶ **DaVis** DIC 2D or 3D software
- ▶ DCU 11 controller including A/D converter
- ▶ tripod based rail mount
- ▶ LEDs
- ▶ M-lite cameras (up to 16 MPix)

Options for **StrainMaster Portable** include

- ▶ high temperature testing capability
- ▶ various lenses for small- and large-scale components

For customers with the most demanding research applications, **StrainMaster** systems can be tailored to your specific DIC needs to investigate materials at the microscale or for high-speed testing. There is no typical system but options include:

- ▶ powerful **DaVis** platform with the DIC 2D or 3D module
- ▶ high-end PCs with increased RAM and RAID arrays
- ▶ PTU X with optional high-speed imaging capability
- ▶ bespoke mounting solutions with translation stages or robots
- ▶ stereo microscopes with very high magnification
- ▶ high-speed cameras offering kHz frame rates
- ▶ combinations of DIC with PIV for fluid-structure interaction (FSI) studies

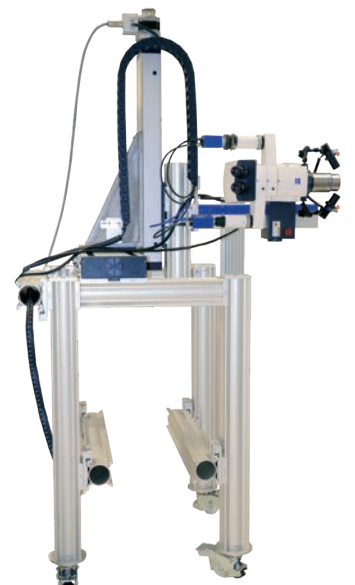



## How does Digital Image Correlation work?

**DIC** tracks the movement and deformation of a random surface pattern as the object undergoes some sort of loading (mechanical, thermal, etc). The surface pattern may be a naturally occurring structure or an artificially created speckle pattern. The recorded images of the object surface are discretized into smaller subsets and the displacement of the pattern in each subset is tracked over time. To find the best match between the initial subset pattern and the same pattern in the deformed state, the pixel greyscale values are correlated. This is typically done via **Least Square Matching** in conjunction with a subset shape function that accommodates pattern transformations like stretch and rotation. The result of this computation is a sub-pixel accurate displacement vector pointing from the center of the initial subset to the new position of the pattern in the deformed state. By tracking the displacement of all subsets, a dense map of displacement vectors is created. Additional quantities like strain are easily computed from the displacement vector field using well established numerical derivation schemes.

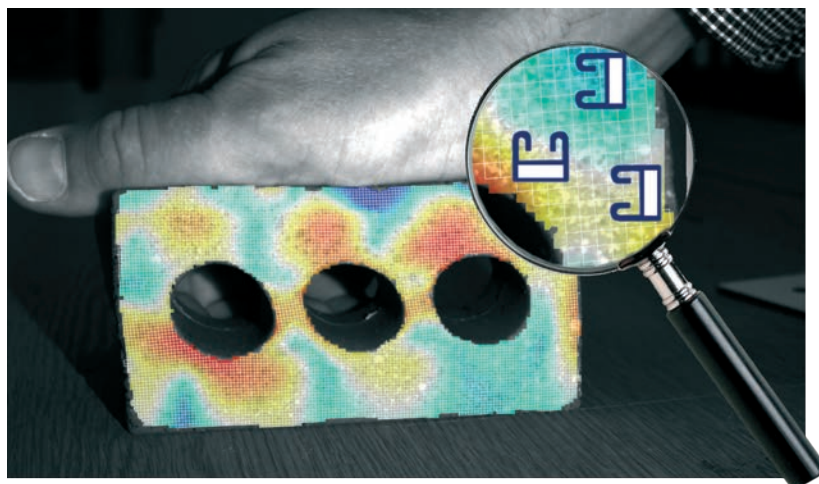
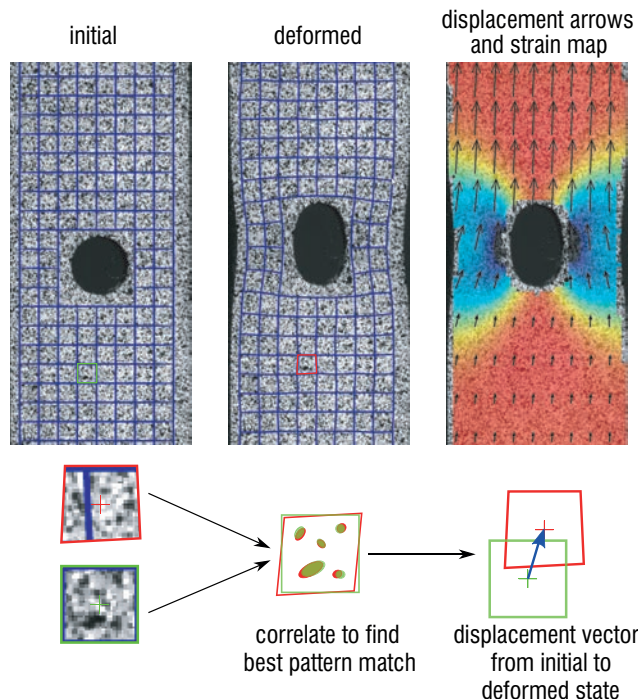

The displacement is calculated over the entire surface allowing the local strain to be calculated. This is done by making an affine fit to the local  $N \times N$  displacement vectors. Essentially one can think of the strain map as like having thousands of tiny strain gauges or extensometers all over the object surface.

As well as not being restricted to certain applications, object sizes, or material types, DIC is not restricted to certain strain magnitudes (unlike traditional gauges or extensometers). By our sum-of-differential correlation mode we can capture very large strains greater than 1000%.

## Calibration

The term “calibration” has different meanings within different communities. **StrainMaster** systems don't require regular calibration checks by the manufacturer because the user calibrates the system for the optical setup. Here the purpose of the calibration is to find the intrinsic and extrinsic parameters of a camera model that best describes the optical system. Intrinsic parameters are mainly characteristics of the lens, like focal length or radial and tangential distortions, while extrinsic parameters define the standoff distance from the object and general camera pose in space.

The simplest calibration for a 2D system would be a pix/mm scaling, however this would not account for optical distortions such as the typical cushion distortion of a short focal length lens shown on the right together with the corrected image (after calibration). Without calibration, the strong compressive distortions around the edges of the raw image would introduce artificial strains in **DIC** when moving a pattern from the center of the image towards the border.

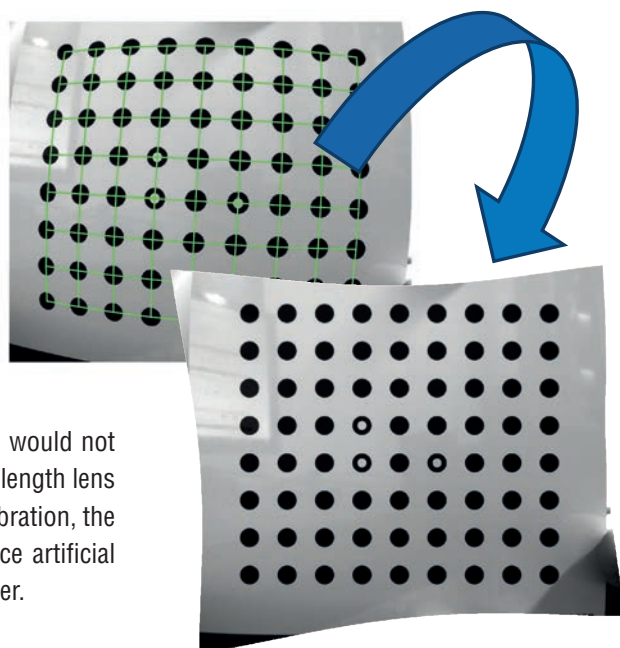

In 3D stereoscopic **DIC** systems two cameras view the surface of the specimen. The camera system is calibrated such that the relationship between raw and world space is known. By matching the pattern between cameras and using the calibration model, the height and z-displacement of the surface can be calculated. This depth perception system works like our eyes do. Through the two views of the object surface and calibration, the Stereo-DIC system calculates the surface shape, displacement and strains. It gives the real strain on the surface even if the object moves towards or away from the camera system, whereas such movement will result in errors in a single camera 2D system.

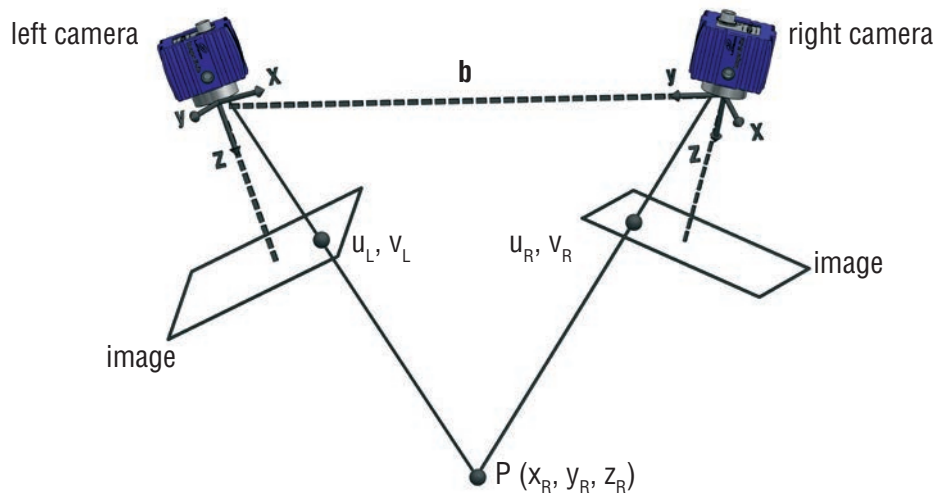

## Accuracy and Precision

The accuracy of a **DIC** measurement is primarily dependent on the image quality. The pattern on the surface is the information carrier and the better the “signal” is from that information carrier, the better the result will be. Typical error sources which need to be considered and optimized include, camera noise, image contrast, focus, reflections and glare. There are also aspects of the calculation scheme like the **DIC** subset size, which influence the precision of individual displacement vectors and hence the strain result. If the experiment is optimized displacement accuracies better than 0.01 pixel, and strain precision of 50  $\mu\epsilon$  or better are achievable in **DIC** measurements. The precision improves even further for virtual strain gauges and extensometers due to larger effective gauge areas and gauge lengths (compared to the locally calculated values).

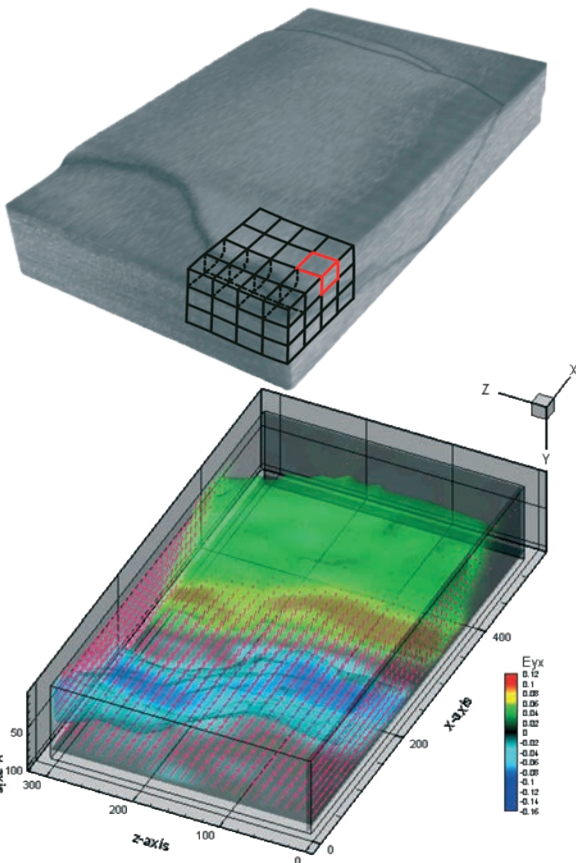

## Digital Volume Correlation (DVC)

A natural extension to **DIC**, which operates using 2D images of the object surface is full 3D correlation using volume images from X-ray CT-scanners, MRI machines, or other volumetric imaging techniques (which may include LaVision’s Tomographic Imaging systems for fluids or transparent materials). With **DVC** the volume imaging system records many image projections of the object in order to reconstruct the 3D volume in the reference and deformed states. The raw reconstructed volume images are then imported into the **DaVis DVC** module for processing.

Like **DIC**, the image is discretized into smaller sub-volumes, and the pattern within each subvolume is matched within the deformed images allowing a full volume map of the displacements and strains to be calculated.

Like **DIC**, the pattern is the information carrier, and therefore **DVC** requires that there exists a natural or artificially introduced pattern within the object. Materials such as bone, foam, soil, concrete and iron all have naturally occurring features which provide different attenuation levels to X-ray CT machines and hence a pattern. With applications such as powder compaction or sandbox experiments (see left – courtesy of Jürgen Adam et al., Royal Holloway University), a small percentage of different powder is introduced to provide the necessary pattern.



## DaVis Platform

LaVision's 2D or 3D DIC software modules are available as part of the **DaVis** platform. The software package allows the user to acquire and process full field surface shape, displacement, and strain data. It is an easy-to-use application for routine industrial and research measurement, or education. The software package contains all necessary modules for material analysis based on **digital image correlation**.

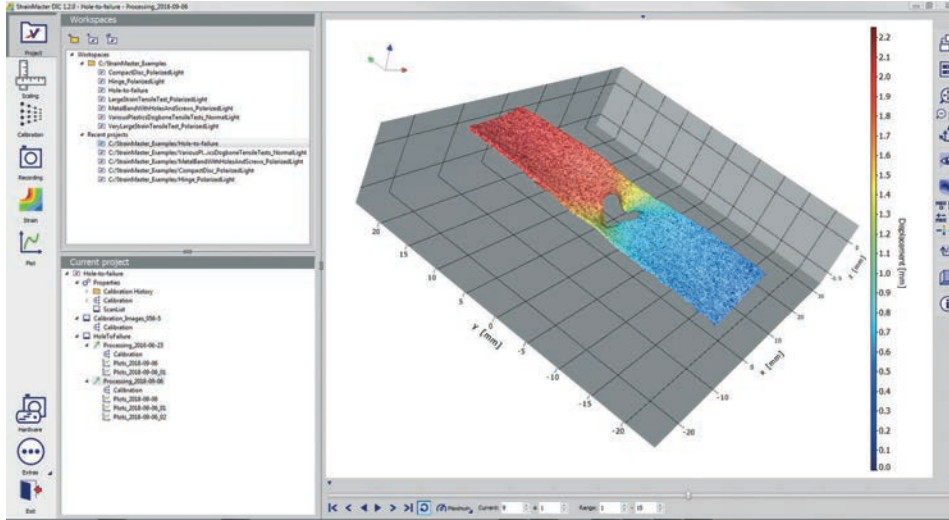

DaVis with graphical user interface

## Calibration

At the heart of the system, the software, gives complete control and management over your data collection, processing, and reporting. The software is extremely intuitive with a logical data and menu structure.

Like any device, the **StrainMaster** system must be calibrated for the test. This is not something that LaVision has to do though - there is no manufacturer system calibration required. You will be trained to calibrate the system; a process which typically takes less than 5 minutes when using our special calibration plates.

Having focussed on the sample in the test machine:

- ▶ you choose the calibration plate type in the drop down menu
- ▶ place the calibration plate in front of the sample
- ▶ the software automatically detects the calibration markers
- ▶ feedback is given on the calibration quality

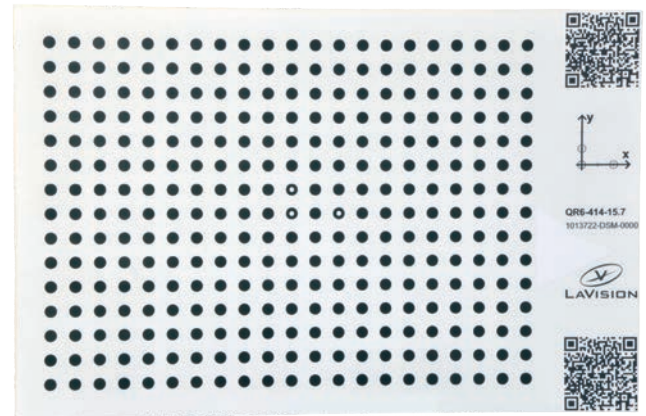

The calibration process enables the system to map from the camera space to the real world space. The calibration plate can be inside a chamber or within a liquid.

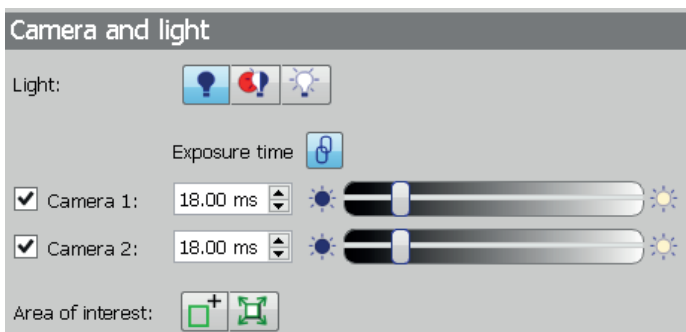

## Recording

Having calibrated the system you are now ready to configure the recording of images and analogue signals (load, displacement) from the test machine.

- ▶ multi-channel A/D recording
- ▶ ability to pause the test without corrupting data
- ▶ fast frame rates to capture dynamics
- ▶ continuous live view of the sample
- ▶ area of interest selection

Image sequences are automatically stored in the project.

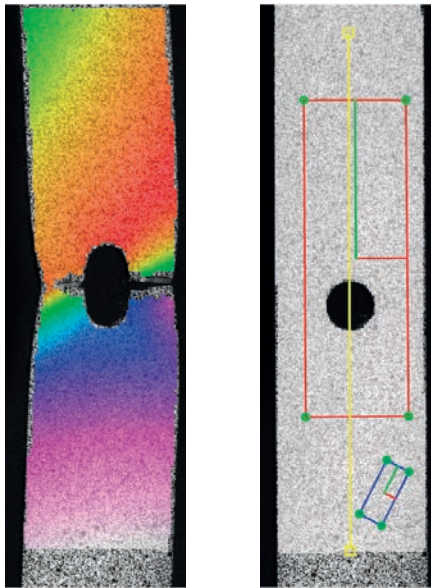

## Strain

With the system calibrated and sequence of images collected during the test you are now able to perform the full field displacement and strain calculation.

- ▶ calculate data for the whole, or just part of the sequence
- ▶ select regions of interest or use AutoMask to automatically isolate the material surface from the background image
- ▶ test your processing scheme
- ▶ choose calculation modes which optimize displacement (and strain) precision or spatial resolution

As part of the calculation process you can choose different display and strain calculation modes depending upon the test and investigation type.

## Extras

- ▶ 2D display with the raw image in the background
- ▶ 3D display to visualize surface shape
- ▶ colour coded surface maps of displacement component or strain
- ▶ choose the strain type (Engineering, Green-Lagrange, Hencky, etc)
- ▶ axial, transverse, shear, or principle strains
- ▶ Poisson's ratio

You now have a rich dataset of full field data covering the whole surface. You can use this to identify strain hot spots, or locate crack initiation and propagation, and export the data in image, text, or finite element formats.

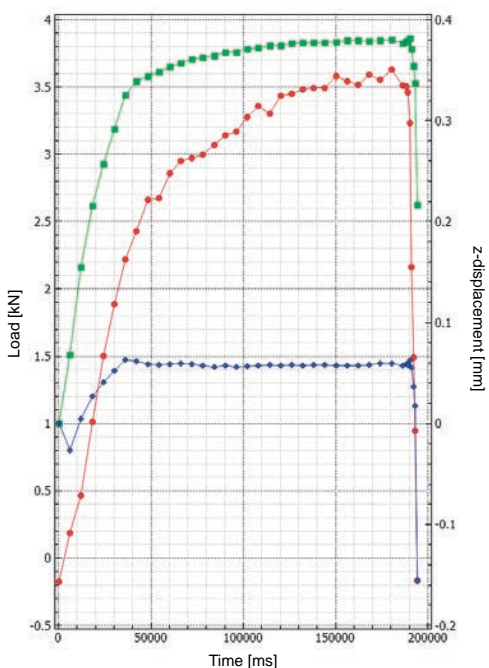
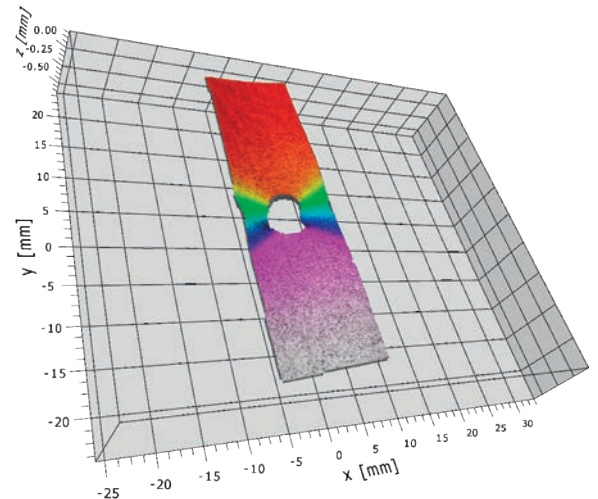

## Plot

You are also able to extract virtual gauge and extensometer plots to make comparisons. You don't need to know where to place the virtual gauge before you start the test!

- ▶ multiple gauges and extensometers
- ▶ strain calculated according to the local gauge orientation
- ▶ plot versus time
- ▶ plot versus recorded data (load, cross head displacement)
- ▶ export data for comparison

**DaVis** software is easy to use and its simple workflow allows you to optimize your material test procedures.



## When is DaVis suitable?

The software package includes all functionality for typical quasi-static DIC testing including:

- ▶ tensile
- ▶ compression
- ▶ 3 and 4 point bend
- ▶ fatigue

The platform supports the **StrainMaster Compact** and **StrainMaster Portable** (M-lite cameras) hardware which are perfect for quasi-static test scenarios. It includes the functionality required by most industrial users and is designed to provide a very straightforward workflow arriving at quick and accurate results.



*Flexure fixture, photo courtesy of Instron®*



## A Range of Materials and Scales

**DaVis** is not restricted to certain types of materials and can be used in 2D or 3D configurations. It will typically be used as a platform where the objects or samples have measurement areas in the range 20 mm – 1000 mm in size.

- ▶ not restricted by material type
- ▶ not restricted by maximum strain range
- ▶ can import images from external sources for processing
- ▶ supports add-on hardware for high temperature testing
- ▶ has calibration routines suitable for working with samples in chambers

## Software Features for many Standard Applications

- ▶ very flexible and versatile data acquisition and device synchronization, including synchronization to external events and user defined trigger lines
- ▶ 2D and 3D visualization of the full field strain map, with a large variety of presentations for vectors, strain and raw images
- ▶ data import and export from and to several image and data formats (AVI, TIFF, PNG, Tecplot®, ABACUS® Matlab®, ASCII, CSV...)
- ▶ ability to measure from 0.01 to 1000 pixel deformation
- ▶ runs under 64 Bit Windows 10®

Because of the system modularity **DaVis** can be upgraded to include the more powerful capabilities within the **DaVis** platform if and when the user decides this is needed.



*Environmental chamber, photo courtesy of Instron®*





The system expandability increases with **DaVis** allowing the user to add-on other LaVision software modules such as 3D volume strain analysis (**digital volume correlation**) and fluid-structure interaction (FSI)

The advanced hardware management in **DaVis** allows control and synchronization of up to 8 cameras, triggering of multiple light sources, 8 channel analogue/digital converter and various other devices such as motorized stages.

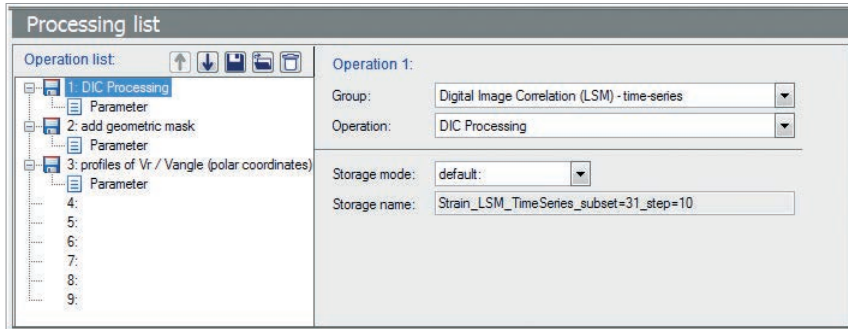
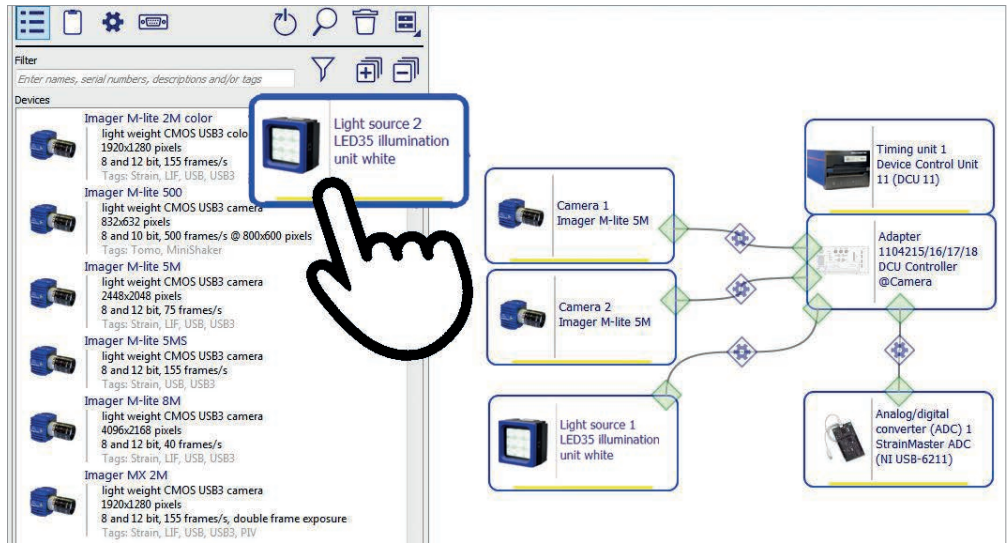

Batch processing dialog

### Advanced Processing Dialog

Batch processing offers the possibility to evaluate several data records with identical structure one after the other with the same parameters using only one start command. A library of routines for data management, filter and statistics functions round off the comprehensive feature package.

### High-speed and $\mu$ DIC Support

A wide range of camera models, light sources, translation stages and microscopes are integrated into and controlled by **DaVis**. Automatic scanning for connected devices, routing of trigger signals, timing capabilities - all are set up under a new visual interface. Combining devices within the **DaVis** platform is straightforward. For the configuration of the hardware it is sufficient to drag & drop icons of the hardware onto the desktop. **DaVis** enables the use of stereo microscopes for  $\mu$ DIC applications as well as high-speed cameras with up to 300,000 fps. Another feature is the synchronization of recording with external events, such as cyclic processes or control loops.



4 camera microscope setup

### Advanced Calibration

Necessary for microscopes with strong distortion, or for cases when viewing through curved windows, **DaVis** provides an advanced calibration routine including polynomial fitting. It also allows the user to calibrate more than two cameras in the world space.

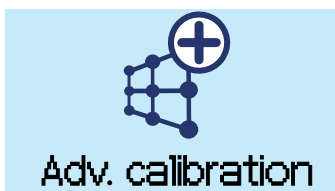



## DaVis DIC – DCU 11 – Compact

Our simplest 3D DIC configuration for repeat testing, teaching, and difficult access areas.

- ▶ 3D DIC software (supports Compact hardware only; upgrade to support Portable)
- ▶ DCU 11 with keyboard and mouse (optionally DCU 11 plus laptop for use with remote desktop) (optionally desktop PC based system incl. PTU and ADC, plus adapter)
- ▶ **StrainMaster Compact** 3D DIC head

## DaVis – DCU 11 - Portable

Flexible and portable 2D or 3D DIC – a system suitable for most quasi-static test scenarios.

- ▶ **DaVis** software
- ▶ **StrainMaster Portable** hardware support module
- ▶ DCU 11 with keyboard and mouse (optionally DCU 11 plus laptop for use with remote desktop) (optionally desktop PC based system incl. PTU and ADC, plus adapter)
- ▶ M-lite camera(s)
- ▶ LED (optionally blue LED for high temperature, fluorescence, or FSI)
- ▶ choice of c-mount or f-mount lenses (optionally polarizing or band pass filters high temperature, fluorescence, or FSI)



## DaVis DIC – Desktop PC - PTU 11

The ultimate in flexible and customizable system to suit all testing requirements.

- ▶ **DaVis** 2D or 3D DIC software
- ▶ **StrainMaster Portable** hardware support module
- ▶ desktop PC
- ▶ internal PCIe or external USB PTU 11
- ▶ internal PCIe or external USB ADC
- ▶ multi camera support including high resolution and high-speed
- ▶ choice of light source
- ▶ choice of mounting system or frame
- ▶ any c- or f-mount lens (f-mount recommended for large sensor cameras)
- ▶ optional filters
- ▶ all other supported suitable LaVision hardware
- ▶ may form the basis for fluid-structure interaction (FSI) systems

Examples of such configurations built around this platform are given opposite.



## DaVis– Desktop PC - PTU 11 - Micro-DIC

Building on the flexible **DaVis** platform this system provides the ultimate in magnification.

Typically includes

- ▶ **DaVis** 2D or 3D DIC software
- ▶ **StrainMaster Portable** hardware support module
- ▶ desktop PC
- ▶ internal PCIe or external USB PTU 11
- ▶ internal PCIe or external USB ADC
- ▶ multi camera support including high resolution and high speed (sensor size may be restricted)
- ▶ small diameter LED (white/blue) and LED controller
- ▶ Zeiss V12 stereo microscope (or similar)
- ▶ choice of microscope lenses with various magnification and working distances

Selection of options

- ▶ translation stages
- ▶ mounting frame
- ▶ blue bandpass filters for high temperature testing

	Desktop PC
	Timing unit 1 Programmable Timing Unit
	Analog/digital converter (ADC) 1 ADC-250-USB (NI USB-6210)
	Cameras
	Translation stage 1 Isel translation stage with iMC-S8 controller
	Microscope 1 Zeiss Microscope

	Desktop PC
	Timing unit 1 PTUX-HS
	Analog/digital converter (ADC) 1 ADC-1250-USB (NI USB-6351)
	Cameras
	Light source 1 LED-Flashlight 300

## DaVis – PTU 11-HS – High-speed DIC

Building on the flexible **DaVis** platform these systems have kHz temporal resolution

Typically includes

- ▶ **DaVis** 2D or 3D DIC software
- ▶ **StrainMaster Portable** hardware support module
- ▶ desktop PC
- ▶ internal PCIe or external USB PTU 11
- ▶ PTU 11 high-speed upgrade
- ▶ 1.25 MHz internal PCIe or external USB ADC
- ▶ fully integrated support for Phantom and Photron high-speed cameras
- ▶ several kHz pulsed light sources are available
- ▶ choice of f-mount lenses

Selection of options

- ▶ twin tripod mounting system



## The Central Control Unit

The **Device Control Unit 11** is the default option in terms of the central controller for the **StrainMaster** system. It is responsible for the camera synchronization and takes over the communication with the other peripherals. For this purpose, it is equipped with all the connections necessary for the operation of a 2D or stereo camera system, including the acquisition of analog data from a connected test device and the voltage supply for two **StrainMaster** LED lights.



*Device Control Unit 11 (DCU 11)*

The desired operating parameters for cameras, triggering and the analog/digital converter are set on the user interface of the **DaVis 10** software, which is used for the recording and to evaluate the images after recording.

- ▶ multiple device control
- ▶ fully synchronized recording
- ▶ supports low-speed recording
- ▶ power support for **StrainMaster** LED lights
- ▶ camera recording frequency changeable with external trigger during image acquisition trigger-output for external devices (e.g. cameras, lights)
- ▶ external start triggers for recording sequence or individual image acquisition
- ▶ **DaVis** DIC software on-board (option)
- ▶ in-system firmware update
- ▶ three/eight (option) ADC channels to collect analog data from test devices
- ▶ optional cable extension to 5 m for camera(s) and LED lights



## Two Operation Modes

Thanks to its compact design, the DCU 11 can be attached directly to the tripod of a **StrainMaster Portable** system, which makes mobile use possible\*. Alternatively, the DCU 11 can be used as a desktop device.

\*A voltage supply of 110 - 230V is required on site – no battery operation possible.

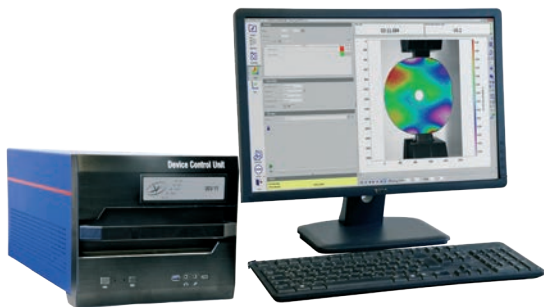

In mobile operation, the control is via a remote-coupled laptop. The laptop takes the function of monitor and keyboard. This is particularly convenient if the user cannot work directly next to the **StrainMaster** system for space or safety reasons and must operate the system from a distance. A PC monitor, keyboard and mouse can be connected for stationary use.

## Connective and Powerful

For measurement operation, the DCU 11 offers connections for two cameras, one trigger input, three or eight (option) A/D channels and two LED lights. The DCU 11 has an integrated Windows 10® computer, which is superior to any laptop with its performance in portable operation. A 500 GB SSD and a 2 TB HDD offer plenty of space for measurement data and a fast evaluation of the tests. For desktop operation, the DCU 11 offers all PC required connections for monitors, USB devices and LAN.

**DaVis** are installed directly on the DCU 11 and can be used for image acquisition and evaluation on this device.



## Programmable Timing Unit PTU X (High-Speed)

With PTU X LaVision is managing complex trigger schemes for standard- and high-speed imaging with multiple devices under challenging conditions, like unevenly running engines or shock tubes. Modern PC interfaces like PCIe and USB improve connectivity to state of the art levels. Improved input and output drivers simplify the use under harsh electrical environments such as engine test beds and turbines with large dynamometers. Software selectable input impedance switches (50 Ohm, High-Z) and low pass filters (1MHz) improve noise resistance without changing the cabling.



### External Unit

The connection is through USB. In order to cover longer distances, LaVision can provide a tested USB extender.

### PTU Features

- ▶ fully synchronized recording
- ▶ multiple device control
- ▶ phase locked trigger
- ▶ user defined triggers
- ▶ device delay control
- ▶ Graphical Connector Interface (GCI)
- ▶ in-system firmware updates
- ▶ different frequency strategies
- ▶ multi exposure
- ▶ engine synchronization (upgrade)
- ▶ flexible independent reference times (upgrade)
- ▶ high-speed support (upgrade)
- ▶ add user-defined trigger lines
- ▶ operate single and dual frame cameras
- ▶ switch between internal and external trigger sources
- ▶ start movie acquisition based on a trigger input
- ▶ synchronize cameras, lasers, and A/D converters and many more devices
- ▶ automatically shift the timing relation between your devices and the trigger (time-scan)
- ▶ automatically scan through the phase of any periodic event
- ▶ group devices together with respect to independent reference times
- ▶ use multiple exposure on the same CCD-image to improve the signal-to-noise ratio

### Fully Synchronized Recording

The PTU X takes control over the synchronization of all devices connected to it. This is not only to trigger the devices at the right time – in steps short as 10 ns and a jitter less than 50 ps – but to accomplish synchronized data readout from all sources. All PTU versions support a phase angle based trigger, when the trigger source has a frequency (internal or external trigger). This means that you can set a trigger not only on the time scale, like in milliseconds, but also as a phase, like „trigger at 120° and 180°“. For use with engines you can also define whether 360° is a full cycle or 720° for 4-stroke engines.

### Internal Card

The internal card has a PCI express (PCIe) interface to match all common computer mainboards. A front panel LED shows the most important status information on the PC front.

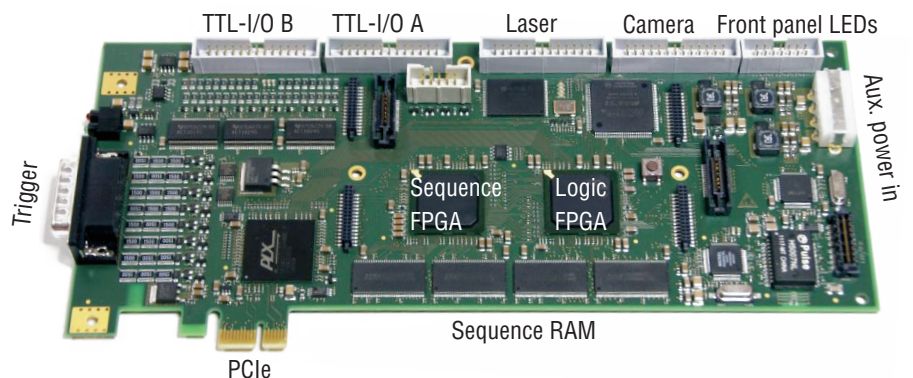



## Compact Stereo-DIC System

The **StrainMaster Compact** is a lightweight Stereo-DIC system featuring two USB 3.0 cameras and bright white or blue LED light source in a compact housing. The system is silent due to passive cooling. The front windows are equipped with linear polarization filters to reduce glare on shiny surfaces. The working distance is 25 cm and the depth of field is about  $\pm 2$  cm. The field of view at the working distance is given by the table below.

Type	Cameras	Camera Resolution	Lens	FOV <sup>1</sup>	Effective Spatial Resolution
SMC 2M-280	2x M-lite 2M	1936 x 1216	2x 12mm	180 x 280 mm <sup>2</sup>	142 $\mu\text{m}/\text{px}$
SMC 2M-200	2x M-lite 2M	1936 x 1216	2x 16 mm	130 x 205 mm <sup>2</sup>	92 $\mu\text{m}/\text{px}$
SMC 5M-180	2x M-lite 5M	2464 x 2056	2x 12 mm	150 x 180 mm <sup>2</sup>	74 $\mu\text{m}/\text{px}$
SMC 5M-140	2x M-lite 5M	2464 x 2056	2x 16 mm	120 x 140 mm <sup>2</sup>	52 $\mu\text{m}/\text{px}$

<sup>1</sup> FOV at a working distance of 25 cm, measured from the front face of the housing.

### Frame rate at max. camera resolution<sup>2</sup> 2M

up to 150 Hz @ 8 bit  
up to 100 Hz @ 12 bit

### 5M

up to 75 Hz @ 8 bit  
up to 50 Hz @ 12 bit  
25 % (pulse-pause-ratio 1:4)

### LED max. duty cycle<sup>3</sup>

### Exposure time

### Connectors

### Size of measurement head (L x W x H)

### Operating temperature

### Software requirements

34  $\mu\text{s}$  – 166 ms  
2x USB 3.0 cable to camera, 5 m length  
1x trigger and power cable, 5 m length  
195 mm x 200 mm x 60 mm  
10° C – 30° C  
**DaVis DIC**



<sup>2</sup> Frame rates increase for smaller AOI's. Maximum rates may only be achieved when recording to RAM.

<sup>3</sup> This is monitored by the electronics, wrong timings will deactivate the light source.

## System Configuration

A complete system consists of at least one **StrainMaster Compact** measurement head, the device control unit DCU 11 and the **DaVis DIC** software package. Optionally the system can be equipped with a remote laptop. Note that measurement heads can be easily exchanged with the existing DCU 11.



### Benefits

- ▶ fully integrated and easy to use stereo system
- ▶ no complicated setup, just point at object and start recording
- ▶ small form factor
- ▶ very rigid design reduces the need to re-calibrate for each measurement
- ▶ reduced cable clutter due to single wire harness
- ▶ ideal for use with uniaxial testing machines

### Extensometer functionality

The integrated video extensometer functionality is equivalent to:

ISO9513<sup>4)</sup> class 0.5

ASTM E83<sup>4)</sup> class B1

The housing has two M6 and one 3/8" thread in the base plate, which facilitate mounting using standard tripods or rail mounts.

<sup>4)</sup> for max gauge length



## Lightweight System with Upgrade Flexibility

The **StrainMaster Portable** hardware offers unparalleled flexibility and excellent stability in a compact package. Building on customer feedback and our experience of **digital image correlation** use in the field, we have developed the **StrainMaster Portable** hardware. A typical system includes a sturdy tripod, flexible gearheads, camera(s), LED illumination units and the Device Control Unit X with integrated A/D converter.

Suitable for a huge range of applications where flexibility and portability is essential, LaVisions **StrainMaster Portable** system is appropriate for a wide range of subject sizes. It allows the user to quickly and easily obtain full field data over the entire material surface.

## Standard 2D DIC System

A standard 2D **StrainMaster** system includes:

- ▶ heavy duty tripod for maximum stability
- ▶ 1 m lightweight horizontal rail
- ▶ 1 x camera gearhead on sliding mount
- ▶ 2 x LED lights
- ▶ 1 x Device Control Unit X
- ▶ 1 x USB 3.0 CCD camera (various models selectable)

## 3D Stereo Upgrade

A standard 3D **StrainMaster** system includes 2D system as above plus:

- ▶ additional camera gearhead on sliding mount
- ▶ second USB 3.0 CCD camera
- ▶ additional 1x LED gearhead on sliding mount

## Optional Mechanical Add-ons

Optional customized mechanics:

- ▶ rail for long reach applications or vertical camera orientation
- ▶ longer rail for larger camera separation
- ▶ test machine mounting solutions



*StrainMaster Portable with stereo camera set-up*



For a safe transport, all components of the **StrainMaster Portable**, such as the rail and mounts, the cameras with lenses, LED lights and the DCU 11 can be packed in a sturdy and clearly arranged roll case. The tripod and laptop are packed in soft cases.

## Characterization of Material Behavior under Heat Influence

In high temperature applications, inhomogeneous heat distribution in the specimen often results in uneven strain fields. Determining this behavior is a task in material and component development. The measurement is particularly difficult if it is not a flat workpiece but a component with complex geometry.



*DIC measurements of a hot (800° C) exhaust manifold - with filter (left) and without filter (right)  
Acknowledgement: images taken during a project with KTH Royal Institute of Technology (Sweden) and Scania.*

Physical sensors such as strain gauges or extensometers reach their limits here. The high temperatures or the possibility of attaching the sensors mechanically to the desired position limit their possible application. In addition, it takes a lot of experience to determine the correct position for the sensor in order to acquire the desired data before the experiment is carried out.



*Hot surfaces during metal cutting*

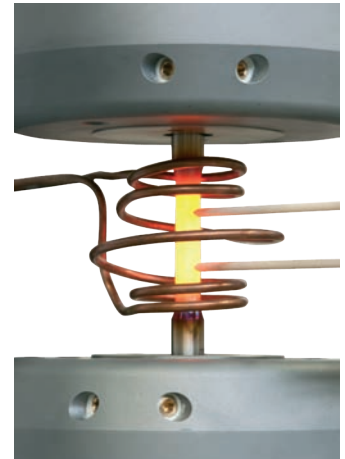
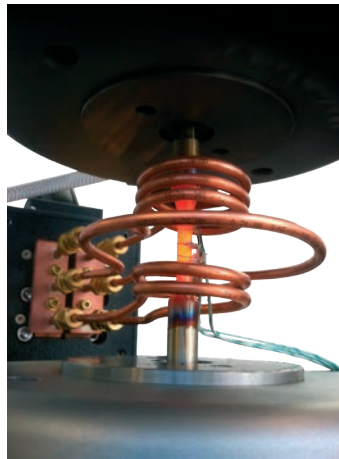

*Thermomechanical Fatigue (TMF) system, photo courtesy of Instron®*

Specimens which are heated exhibit black body radiation which can easily obscure the visible surface pattern. A combination of blue lighting and the matching filter allows to block out the glow from the surface. We are also able to give advice in terms of surface preparation suitable at very high temperatures (>1000° C).

A particular advantage for the user is the flexibility in evaluation, as the strain gauges and extensometers can be placed as virtual sensors at any position and in any size on the specimen surface. Interesting surfaces and anomalies in material behavior can be investigated in detail without additional experiments.

- ▶ full-field surface analysis
- ▶ determination of the position of sensors after completion of the experiment
- ▶ no influence on the sample during the experiment
- ▶ can also be used at high temperatures



*Blue LED illumination unit*



High-speed cameras are increasingly being used in materials research to evaluate impact, compression or fracture tests with **digital image correlation**. LaVision offers a wide range of cameras with up to 300.000 fps for this task.

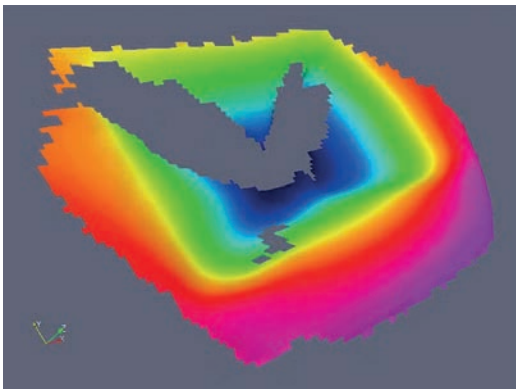
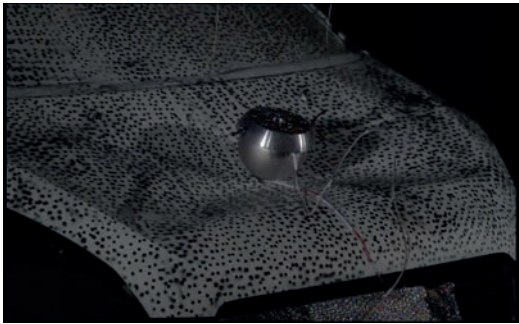

*Impact test on a car bonnet*

LaVisions customized systems are individual adapted to your experiment and include the triggering of cameras and illumination devices by using our **PTU X High-Speed** controller.

- ▶ recording, image correlation, plot evaluation with one software
- ▶ import of images from external cameras possible
- ▶ complete access to camera recording parameters such as frame rate and exposure
- ▶ multiple triggering schemes possible



*PTU X High-Speed*

Analog data such as force, displacement, etc can be acquired with an optionally available analog/digital converter with up to 1.25 MHz. With the all-in-one software package **DaVis** you get a powerful tool for image acquisition (including pre- and post-triggering), 2D or Stereo-DIC calculation and further evaluation with virtual extensometers and strain gauges, with subsequent display as plot graphics.

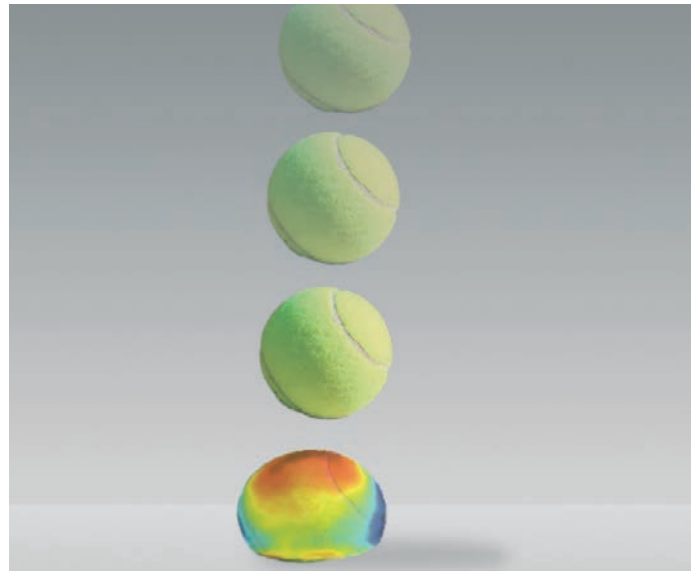



## Technology for Small Scale, Full Field Strain Measurement

**StrainMaster  $\mu$ DIC** can be supplied as a complete system or as stand-alone software for importing and processing images from an external, high magnification sources such as SEM, thus providing a versatile range of Fields of View and working distances.

Systems can be configured with LaVisions complete range of cameras depending on the strain rate of the test (or the frame rates desired), and the resolution of the chip. Cameras capable of frame rates up to 300 KHz are available, and resolutions between 1 Mpix up to 29 Mpix.

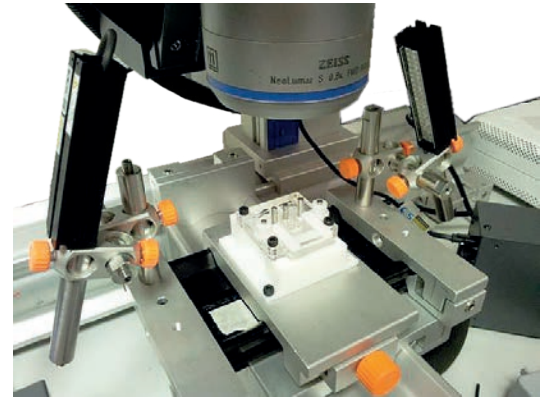

Where better resolution and higher magnifications are required but the working distances from the object are not restricted, a high magnification zoom lens can provide excellent image quality.

- ▶ 3.5 x magnification at 341 mm working distance
- ▶ 28 x magnification at 37 mm working distance



## 2D $\mu$ DIC

2D microscopes with significant zoom capabilities in the body and very high optical resolution can also be used in combination with various cameras; mounted either vertically or horizontally to allow greater flexibility when setting up and focusing the system on the desired area of interest. The image here shows a high-speed camera and microscope combination.



## Stereo- $\mu$ DIC

Any movement of the sample towards or away from the camera cannot be quantified by single camera setup, and as a result may appear as artificial displacements and strains. With a 2 camera stereo setup any slight misalignments or off-axis movements are measured and, therefore, that error source is eliminated.

During  $\mu$ DIC experiments it is often very difficult to constrain sample displacements to be perfectly in one plane only, and even small misalignments on the  $\mu$ m scale can show up as errors in a measurement. As a result LaVision would always recommend a stereo setup. The systems can be configured to be in a vertical orientation, where bench top testing is possible, or as a horizontal mounting where the system is to observe traditional UTM/cyclic type testing.

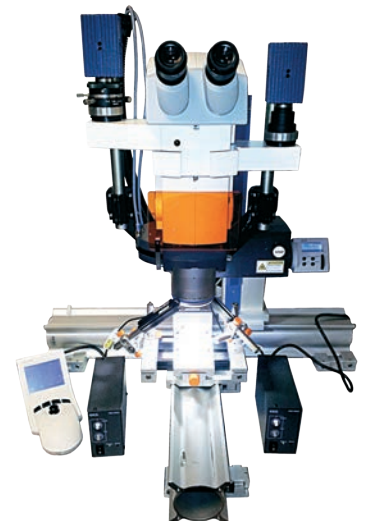

## Full Field Experimental Measurement Systems

**Fluid-structure interaction** is the study of fluid flow causing deformation of a surface or structure. Because of the interaction and the change of the surface profile, this results in a change in the fluid flow path: the behavior of the fluid depends upon the surface shape, and the surface shape depends upon the fluid forces imparted on the surface. This interaction between fluid and structure may result in periodic or cycling instabilities which can establish **fluid induced vibrations (FIV)**. LaVision offer systems which can simultaneously measure and quantify the fluid and surface behavior.

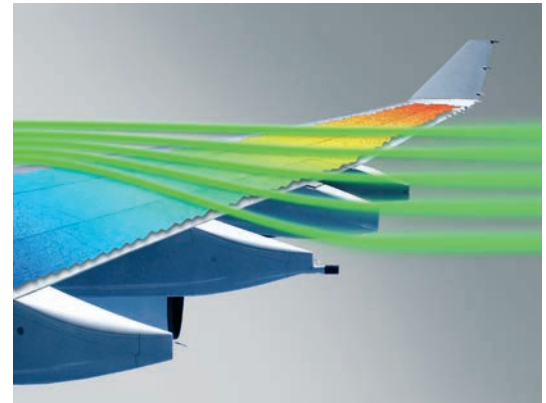

## Methods

- ▶ **Particle Image Velocimetry** utilizes short pulses of laser light separated by known time intervals to illuminate a plane (or volume) of the seeded airflow. By imaging this it is possible to accurately ascertain a map of velocities
- ▶ **digital image correlation** images a surface and is able to track the shape and deformation of that surface

By coupling our PIV and DIC technology we are able to measure the **fluid-structure interaction** behavior allowing users to validate and optimize their simulations. FSI phenomena can be complex and non-linear, especially with today's novel materials and flexible lightweight components, and therefore experimental validation is increasingly important. **fluid-structure interaction** effects are present in many different applications.

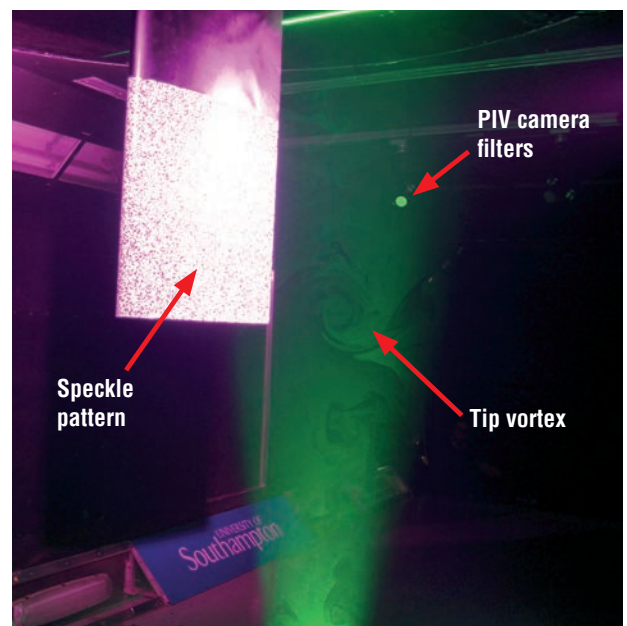
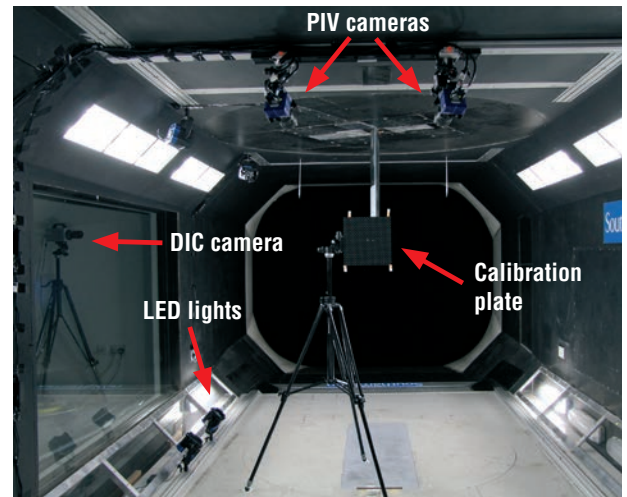
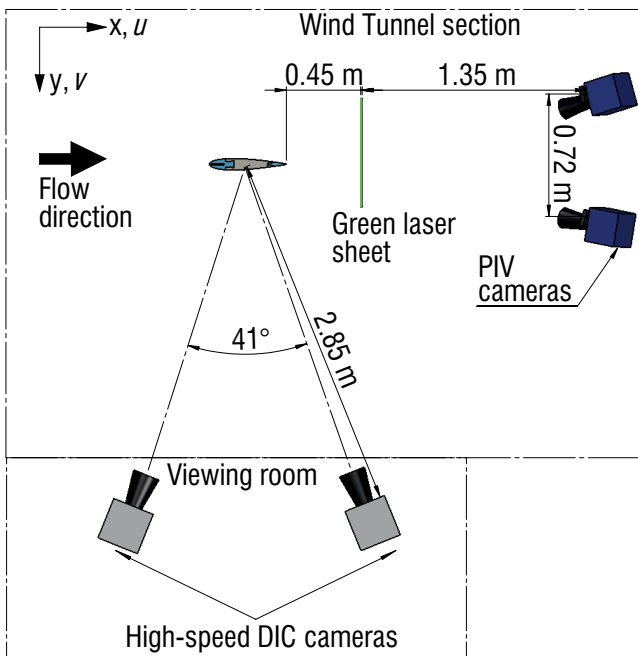

**Fluid-structure interaction** systems from LaVision can work in a variety of modes depending upon the needs of the customer:

- ▶ measuring fluid and structure behavior simultaneously
- ▶ measurements to gather instantaneous snapshots, time averaged, or phase locked data
- ▶ identifying transient coupling features

Images courtesy of the University of Southampton (RJ Mitchell Windtunnel)

# StrainMaster

## System Components & Accessories

With an extensive range of accessories, all **StrainMaster** systems can be optimally adapted to a given test setup.

- Cameras**
- ▶ large selection of cameras for strain and deformation analysis. Depending on your needs we offer high resolution and high frame rate cameras
  - ▶ Imager M-lite, the high sensitivity, high resolution digital USB 3.0 camera series
  - ▶ Imager CS camera series are high sensitivity, high resolution digital cameras, equipped with the new generation CMOS sensors with excellent image quality and low readout noise
  - ▶ Photron and Phantom cameras are ready for use in time-resolved applications featuring very high strain rate testing such as impact or blast

- Optics**
- ▶ high quality standard C- and F-mount lenses covering a range of working distances and fields of view
  - ▶ 2D and stereo microscopes
  - ▶ zoom lens system
  - ▶ long distance microscopes allow an extremely high magnification and resolution while maintaining a long working distance
  - ▶ camera filter for use with polarized and UV light or for blue light for high temperature application

- Sample Preparation**
- ▶ easy to use speckle pattern toolkit for surface preparation of specimens

- Light sources**
- ▶ LED light, white, in constant or pulsed mode synchronized to other devices
  - ▶ polarized light to eliminate glare and specular reflections from the specimen surface
  - ▶ LED light, blue for high temperature experiment
  - ▶ UV LED panel
  - ▶ high power LEDs

- Calibration Plates**
- ▶ The basis for accurate multi-dimensional strain experiments is a precise calibration of the cameras.
  - ▶ for the calibration of stereoscopic camera systems LaVision provides Single-Sided Dual Plane (SSDP) and Single-Sided Single Plane (SSSP), easy to use calibration plates from 20 x 20 mm up to 1 m x 1 m.

- Mounts**
- ▶ additional rail (1m) and fixing mount for long reach applications or vertical orientation
  - ▶ a magic arm with magnetic holder allows individual positioning of illumination devices or lightweight cameras
  - ▶ customized mounts for stationary use of the **StrainMaster** system

LaVision experts are devoted to providing the best high-end solutions which are involved in the latest research in all fields of optical strain analysis. This yields high flexibility for modification and adaptation in high-end research and development.

LaVision offers customer workshops, short courses and in-house trainings.

### LaVisionUK Ltd

2 Minton Place / Victoria Road  
Bicester / Oxon / OX26 6QB / United Kingdom  
E-Mail: [sales@lavisounuk.com](mailto:sales@lavisounuk.com)  
[www.lavisounuk.com](http://www.lavisounuk.com)  
Phone: +44-(0)-870-997-6532  
Fax: +44-(0)-870-762-6252

### LaVision GmbH

Anna-Vandenhoeck-Ring 19  
D-37081 Göttingen / Germany  
E-Mail: [info@lavisounuk.com](mailto:info@lavisounuk.com)  
[www.lavisounuk.com](http://www.lavisounuk.com)  
Tel.: +49-(0)5 51-9004-0  
Fax: +49-(0)551-9004-100

### LaVision Inc.

211 W. Michigan Ave. / Suite 100  
Ypsilanti, MI 48197 / USA  
E-Mail: [sales@lavisouninc.com](mailto:sales@lavisouninc.com)  
[www.lavisouninc.com](http://www.lavisouninc.com)  
Phone: (734) 485 - 0913  
Fax: (240) 465 - 4306